

PPL™ 106 Series

Revisions

REV	Date	By	Description
A	01/30/18	IA	Released
A	01/30/18	PPE	Released

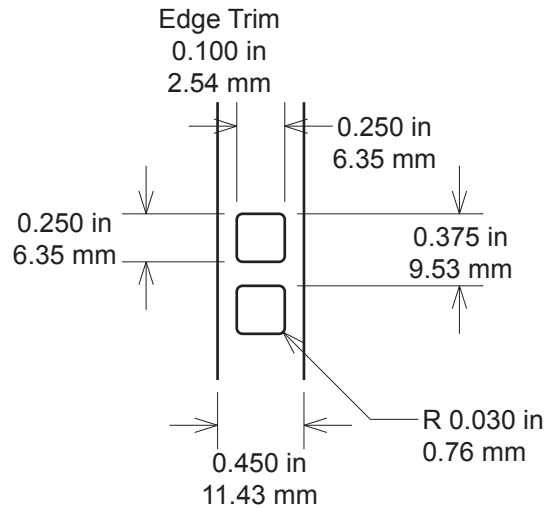

NOTES:

- | |
|---------------------------------------|
| (1) All labels supplied on REEL-E™ |
| (2) Standard Qty/Roll = 10,000 pieces |
| (3) 1 foot leader |
| (4) 1 foot trailer |

With Paper Liner

Part Number	Material Description	TTRR™	USA • EU • IA • IM
PPL-106-416-10	Economy gloss white polyimide	B,D	● ● ● ●
PPL-106-403-10	Gloss white polyimide	B,D	● ● ● ●
PPL-106-433-10	Hi-performance gloss white polyimide	CR	● ● ● ●
PPL-106-451-10	ESD semi-gloss white polyimide	B,D	● ● ● ●
PPL-106-481-10	Low profile gloss white polyimide	B,D	● ● ● ●

1mm
Quiet
Zone

Type of bar code required.

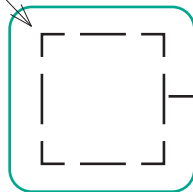

DATAMATRIX

Indicates
barcode
position

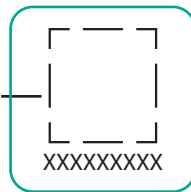

DATAMATRIX
HUMAN READABLE

With Film Liner

Part Number	Material Description	TTRR™	USA • EU • IA • IM
PPL-106-416FL-10	Economy gloss white polyimide	B,D	● ● ● ●
PPL-106-403FL-10	Gloss white polyimide	B,D	● ● ● ●
PPL-106-433FL-10	Hi-performance gloss white polyimide	CR	● ● ● ●
PPL-106-451FL-10	ESD semi-gloss white polyimide	B,D	● ● ● ●
PPL-106-481FL-10	Low profile gloss white polyimide	B,D	● ● ● ●

NOT TO SCALE

Proprietary - Property of IDENTCO

Standard Tolerances	Label dimension	± .010" (.254 mm)
Label tolerances are as stated unless otherwise noted.	Edge trim/web size	± .03125" (.79375 mm)



Labels for Life.

PPL™ 106 Series

Size: 0.25" x 0.25" (6.35 mm x 6.35mm)